

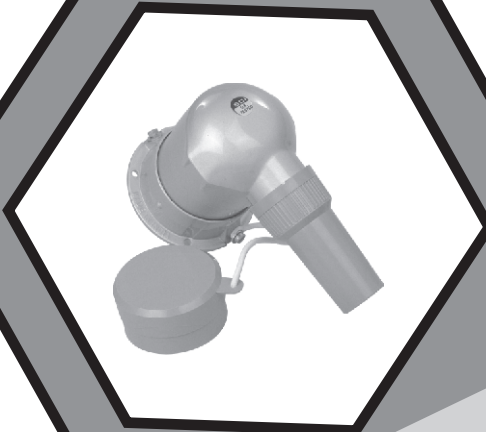

AN ISO 9001 : 2015 COMPANY

PRICE LIST

w.e.f. Jan. 2022

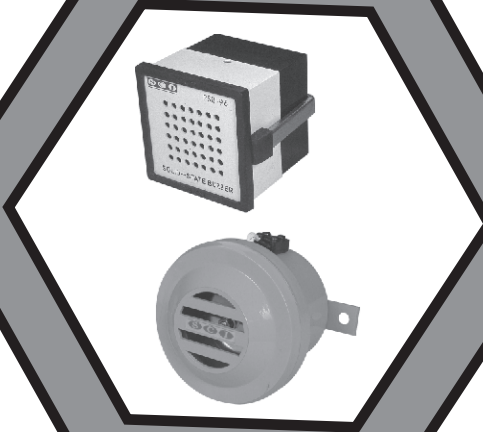
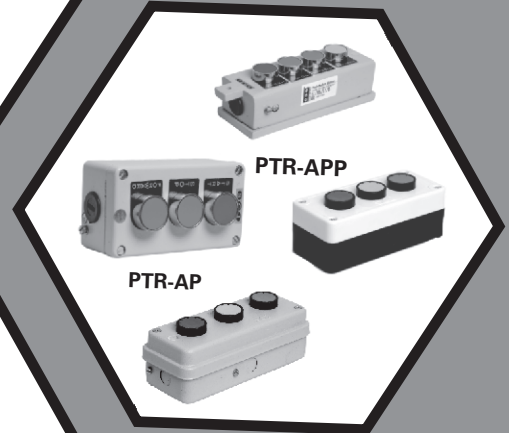
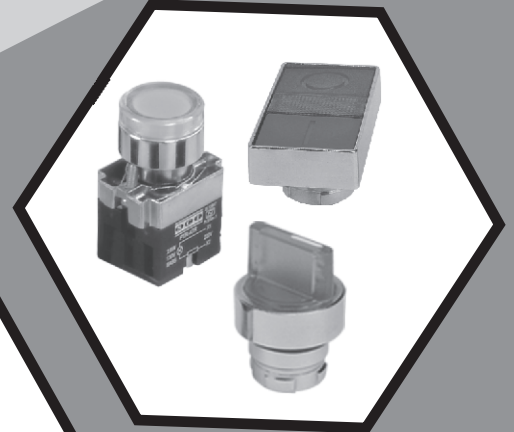

SWITCH CONTROL (INDIA)

L. V. SWITCH GEAR & CONTROL GEAR
Advancing Switch Control Integration

I N D E X

CONTENTS	PAGE
■ METAL CLAD PLUGS & SOCKETS	02
■ H.R.C. FUSE BASES OPEN TYPE	02
■ H.R.C. FUSE HOLDERS	02
■ 22.5 mm DIA PTR SERIES PUSH BUTTON & SELECTOR ACTUATORS	03
■ 22.5 mm DIA PTR SERIES CONTACT ELEMENTS	03
■ 22.5 mm DIA PTR SERIES LUMINOUS ACTUATORS	03
■ 22.5 mm DIA PTR SERIES PILOT LIGHTS (INCLUDING L.E.D. TYPE)	04
■ 22.5 mm DIA PTR SERIES PUSH BUTTON STATIONS	04
■ 22.5 mm DIA PTR SERIES SPARES AND ACCESORIES	04
■ 22.5 mm PUSH BUTTON UNITS (PLASTIC BODY)	05
■ 22.5 mm PUSH BUTTON UNITS (SHEET METAL HOUSING)	05
■ SOLID STATE BUZZERS	05
■ FUSE LINK	05
■ CAM OPERATED ROTARY SWITCHES (6A)	06
■ AMMETER SELECTOR SWITCHES	07
■ VOLTMETER SELECTOR SWITCHES	07
■ CAM OPERATED ROTARY SWITCHES (10A, 16A, 25A, 32A, 40A, 63A)	08
■ CAM OPERATED ROTARY SWITCHES MOTOR DUTY APPLICATIONS	09
■ CAM OPERATED ROTARY SWITCHES FORWARD-OFF-REVERSE, PHASE CHANGEOVERS	09
■ CAM OPERATED ROTARY SWITCHES FOR CHANGEOVER & METAL BOX ENCLOSURES	10
■ SWITCHES WITH METAL BOX	10
■ SPRING RETURN SWITCHES	10
■ CAM OPERATED ROTARY SWITCH SPARES	11
■ TERMS AND CONDITIONS	11

w.e.f. Jan. 2022

METAL CLAD PLUGS & SOCKETS (ALUMINIUM DIE CAST) TYPE-SC

DESCRIPTION	RATING AMPS.	CAT NO.	UNIT PRICE	STD. PACKING
PLUGS				
2 Pole + Earth, 250V	10 A	DP 10	124.00	20
2 Pole + Earth, 250V	20 A	DP20	140.00	20
3 Pole + Earth, 440V	20 A	TP20	182.00	20
3 Pole + Earth, 440V	30 A	TP30	364.00	12
SOCKETS				
2 Pole + Earth, 250V	10 A	DS 10	130.00	20
2 Pole + Earth, 250V	20 A	DS 20	156.00	20
3 Pole + Earth, 440V	20 A	TS 20	192.00	20
3 Pole + Earth, 440V	30 A	TS 30	390.00	12



Conduit Box For DS 10-Rs. 40.00, For DS 20-Rs. 44.00, For TS 20-Rs. 48.00, For TS 30-Rs. 54.00

PLUGS & SOCKETS IN SHEET STEEL ENCLOSURE (WITHOUT MCB)



DESCRIPTION	RATING AMPS.	CAT NO.	UNIT PRICE	STD. PACKING
2 Pole + Earth, 250V Plug & Socket In S.S. Enclosure	10A	DPSB10	670.00	01
2 Pole + Earth, 250V Plug & Socket In S.S. Enclosure	20A	DPSB20	765.00	01
3 Pole + Earth, 250V Plug & Socket In S.S. Enclosure	20A	TPSB 20	1152.00	01
3 Pole + Earth, 250V Plug & Socket In S.S. Enclosure	30A	TPSB 30	1522.00	01

HRC FUSE BASES TYPE FBO

DESCRIPTION	CAT NO.	UNIT PRICE	STD. PACKING
160 Amps In Bakelite Moulding With Circlip Contact	FBO-160C	240.00	10
250 Amps In Bakelite Moulding With Circlip Contact	FBO-250C	645.00	01
400 Amps In Bakelite Moulding With Circlip Contact	FBO-400C	940.00	01
630 Amps In Bakelite Moulding With Circlip Contact	FBO-630C	1274.00	01
160 Amps In DMC Moulding With Circlip Contact	FBO-160CD	270.00	01
250 Amps In DMC Moulding With Circlip Contact	FBO-250CD	720.00	01
400 Amps In DMC Moulding With Circlip Contact	FBO-400CD	1035.00	01
630 Amps In DMC Moulding With Circlip Contact	FBO-630CD	1310.00	01
250 Amps In Sheet Metal Plate	FBO-250LT	900.00	01
400 / 630 Amps In Sheet Metal Plate	FBO-630LT	1060.00	01

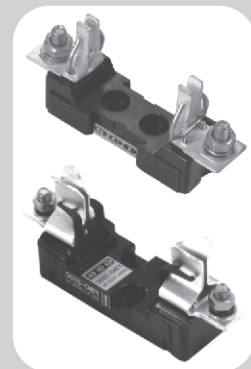

BAKELITE MOULDED FUSE HOLDERS TYPE SC



DESCRIPTION	CAT NO.	UNIT PRICE	STD. PACKING
20 Amps Front Connection	SC-20H	104.00	10
20 Amps Bus Bar Connection	SC-20B	132.00	10
20 Amps Back Connection	SC-20P	180.00	10
32 Amps Front Connection	SC-32H	212.00	10
32 Amps Bus Bar Connection	SC-32B	242.00	10
63 Amps Front Connection	SC-63H	290.00	10
63 Amps Bus Bar Connection	SC-63B	342.00	10
125 Amps Front Connection	SC-125H	694.00	10
125 Amps Bus Bar Connection	SC-125B	762.00	10

ACTUATORS WITH METALLIC FRONT RING AND BEZEL

**PTR SERIES-
CUTOUT DIA 22.5 mm**

DESCRIPTION	CAT NO.	UNIT PRICE	STD. PACKING
Flush Buttons -	PTR-AS	72.00	20
Flush Booted Button -	PTR-ADP	100.00	20
Projecting Button -	PTR-AU	86.00	10
Mushroom Button -	PTR-AM	112.00	10
Mushroom Stayput-Press To Lock And Turn To Release	PTR-AMS	122.00	10
Mushroom Jumbo Button Press To Lock Turn To Reset	PTR-AJB	168.00	05
Mushroom Jumbo Button Spring Return	PTR-AJBS	174.00	05
Selector Two Position Maintained	PTR-A22	145.00	10
Selector Two Position Spring Return	PTR-A22S	145.00	10
Selector Three Position Maintained	PTR-A33	145.00	10
Selector Three Position Spring Return	PTR-A33S	145.00	10
Key Selector Two Position Lockable In Bath Position	PTR-A2K	244.00	10
Key Selector Three Position Lockable In Both Position	PTR-A3K	244.00	10
Emergency Stop Press To Lock And Key To Reset	PTR-APL	334.00	10
Twin-spring Return, G Knob Marked 'I' & R Knob Marked 'O'	PTR-ATB	130.00	20



CONTACT ELEMENT SUITABLE FOR ACTUATORS



DESCRIPTION	CAT NO.	UNIT PRICE	STD. PACKING
NO Contact For Rear Connection	PTR-A1	54.00	50
NC Contact For Rear Connection	PTR-A2	54.00	50

LUMINOUS ACTUATOR WITH METALLIC FRONT RING AND BEZEL



DESCRIPTION	CAT NO.	UNIT PRICE	STD. PACKING
Luminous Spring Return Actuator, With Poly Carbonate Lens, Bulb, Series Resistor For 220V, 110V, 48V, 24V	PTR-ATR	172.00	10
Luminous Spring Return Actuator With Poly Carbonate Lens And Cluster L.E.D. For 220V, 110V, 48V, 24V AC or DC	PTR-ATLED	216.00	10
Twin Luminous Spring Return Green Knob Marked 'I' & Red Knob Marked 'O' With Amber Lamp, Series Resistor Suitable For 220V, 110V, 48V, 24V	PTR-ATBLR	252.00	08
Twin Luminous Spring Return Green Knob Marked 'I' & Red Knob Marked 'O' With Poly Carbonate Lens & Cluster L.E.D For 220V, 110V, 48V, 24V AC or DC	PTR-ATBLED	212.00	08
Luminous Selector 2 Position With Poly Carbonate Knob, Bulb Series Resistor For 220V, 110V, 48V, 24V	PTR-A2PLSR	244.00	10
Luminous Selector 2 Position With Poly Carbonate Lens & Cluster L.E.D. For 220V, 110V, 48V, 24V AC or DC	PTR-A2PLLED	244.00	10
Luminous Selector 3 Position With Poly Carbonate Knob, Bulb Series Resistor For 220V, 110V, 48V, 24V	PTR-A3PLSR	244.00	10
Luminous Selector 3 Position With Poly Carbonate Lens & Cluster L.E.D. For 220V, 110V, 48V, 24V AC or DC	PTR-A3PLLED	244.00	10

PILOT LIGHT (INCLUDING L.E.D. TYPE)

w.e.f. Jan. 2022



DESCRIPTION	CAT NO.	UNIT PRICE	STD. PACKING
Pilot Light With Poly Carbonate Lens, Lamp Holder, Bulb, Series Resistor Suitable For 220V, 110V, 48V, 24V	PTR-ALR	140.00	10
Pilot Lights With Poly Carbonate Lens With Cluster L.E.D For 220V, 110V, 48V, 24V	PTR-ALED	172.00	10
Pilot Lights In Barrel Type Poly Carbonate Lens With Surface Mounted L.E.D For 220V, 110V, 48V, 24V	PTR-AFLED	82.00	20

- For Blue/White Colour Add Rs. 50 Each In The Above Prices
- Colours Available are: Red, Amber, Yellow, Blue and White

PUSH BUTTON STATION

SURFACE MOUNTING ALUMINUM CASTING			PENDENT ALUMINIUM CASTING
DESCRIPTION	PTR-AP SERIES		PTR-APP SERIES
ONE WAY	PTR-API	480.00	552.00
	API + AMS	526.00	
TWO WAY	PTR-AP2	670.00	770.00
	AP2 + AMS	720.00	
THREE WAY	PTR-AP3	892.00	1040.00
FOUR WAY	PTR-AP4	1130.00	1270.00
SIX WAY	PTR-AP6	1940.00	2140.00
EIGHT WAY	PTR-AP8	2440.00	2680.00
TEN WAY	PTR-AP10	2900.00	3190.00
TWELVE WAY	PTR-AP12	3470.00	3800.00
FOURTEEN WAY	PTR-AP14	4042.00	4420.00
EIGHTEEN WAY	PTR-AP18	5540.00	6090.00

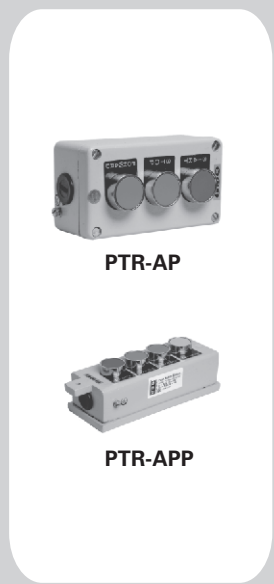

Standard packing is 01 for all, except PTR-AP1 which is 02

- For Push Button Station With Canopy, Add 10% Extra On The Above Prices.
- All Above Push Button Stations Have Flush Button With 1NO or 1NC Contact Element.
- Different Actuator/Contact Block Arrangement Can Be Quoted On Request

PTR SERIES SPARES AND ACCESORIES

DESCRIPTION	CAT NO.	UNIT PRICE	STD. PACKING
Legend Plates With Inscription On, Off, Start, Stop, Forward, Reverse, Test, Accept, Emergency, Reset & Blank	PTR-ASLP	14.00	100
Poly Carbonate Lens Without Lens Holder Suitable For Pilot Light	PTR-ASL	18.00	50
Lens Holder Assembly With Poly Carbonate Lens	PTR-ASLA	85.00	20
Lens Holder Assembly With Poly Carbonate Lens & Ring Suitable For Luminous Light	PTR-ASILA	90.00	20
Filament Bulb BA-9S 2.6 Watt In 130V, 110V, 48V, 24V	PTR-ASBL	47.00	100
Protective Rubber Boot	PTR-ASPB	37.00	20
Bulb Extractor (bulb Puller)	PTR-ASBE	37.00	10
Adopter For Fixing Dia 22.5 mm In Dia 30.5 mm Hole	PTR-ASAP	24.00	50
Blanking Plug For Dia 22.5 mm Hole	PTR-ASBP	29.00	50

w.e.f. Jan. 2022

PUSH BUTTON UNITS (PLASTIC BODY) 1NO + 1NC (PANEL CUTOUT DIA 22.5 mm)

DESCRIPTION	CAT NO.	UNIT PRICE	STD. PACKING
Flush Knob 1 NO + 1NC	PTR-BTH	37.00	20



PUSH BUTTON UNITS (PLASTIC BODY) 1NO + 1NC (PANEL CUTOUT DIA 29.5 mm)

Flush Knob 1 NO + 1NC	PTR-AD	43.00	20
-----------------------	--------	-------	----



• Colours available are : Red, Green, Yellow, Black, White and Blue

PUSH BUTTON CONTROL UNITS (PLASTIC DUAL COLOUR) WITH 1NO + 1NC (DIA 22.5 mm)

DESCRIPTION	CAT NO.	UNIT PRICE	STD. PACKING
One Way with BTH (Dia 22.5 mm)	PTR-P1	140.00	2
Two Way with BTH (Dia 22.5 mm)	PTR-P2	220.00	1
Three Way with BTH (Dia 22.5 mm)	PTR-P3	270.00	1



Please contact to dealer for PTR-THF Push Button Control Units.

PUSH BUTTON CONTROL UNITS WITH 1NO + 1NC - POWER COATED SHEET METAL HOUSING

DESCRIPTION	CAT NO.	UNIT PRICE	STD. PACKING
One Way with BTH (Dia 22.5 mm)	PTR-AS1	167.00	2
Two Way with BTH (Dia 22.5 mm)	PTR-AS2	235.00	1
Three Way with BTH (Dia 22.5 mm)	PTR-AS3	320.00	1



Please contact to dealer for PTR-THF Push Button Control Units.

SOLID STATE BUZZERS TYPE - AB

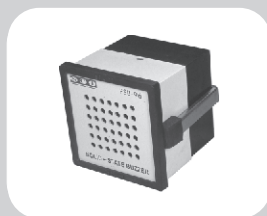

DESCRIPTION	CAT NO.	UNIT PRICE	STD. PACKING
Moulded Housing, Suitable For 230V, 110V, 48V, 24V AC (96 x 96)	PTR-ABA/ABD	770.00	01
Moulded Housing, Suitable For 230V, 110V, 48V, 24V AC (96 x 96) (MULTI TONE)	PTR-ABAM/ABDM	840.00	01
Moulded Housing, Suitable For 230V, 110V, 48V, 24V AC (72 x 72)	PTR-ABAS/ABDS	660.00	01
Moulded Housing, Suitable For 230V, 110V, 48V, 24V AC (72 x 72) (MULTI TONE)	PTR-ABAMS/ABDMS	784.00	01

INDUSTRIAL HOOTERS TYPE-AH

DESCRIPTION	CAT NO.	UNIT PRICE	STD. PACKING
Electronic Hooter 24V, 48V, 110V, 230V AC/DC	PTR-EH	640.00	01
Industrial Mechanical Hooter, Suitable For 230V, 110V, 48V, 24V AC	PTR-AHA	820.00	01
Industrial Mechanical Hooter, Suitable For 220V, 110V, 48V, 24V DC	PTR-AHD	940.00	01

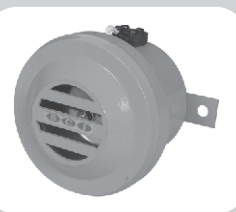

SCNS TYPE FUSE LINK WITH STAGGERED TAGS 415V AC

RATING AMPS.	CAT NO.	UNIT PRICE	STD. PACKING
2A	SC-NS2	40.00	20
To	To		
32A	SC-NS32		

TYPE T-660 AC OFFSET TAGS (2 HOLE FIXING-BOLTED)

RATING AMPS.	CAT NO.	UNIT PRICE	STD. PACKING
32A	SC-TIA32	81.00	10
63A	SC-TIS63	91.00	10
100A	SC-TCP100	210.00	10
125A	SC-TCP125	242.00	10

Fuse link confirm to IS : 13703 IEC 269



CAM OPERATED ROTARY SWITCHES (SWITCHES - 6 AMPS. TYPE 'SC6')

SWITCHING	POLE	PROGRAMME	UNIT PRICE	SWITCHING	POLE	PROGRAMME	UNIT PRICE
ON – OFF (60°)	1	SI001	130.00	SIX WAY NO OFF (60°)	1	SI052	252.00
	2	SI002	160.00		2	SI072	452.00
	3	SI003	175.00		3	SI092	624.00
	4	SI004	194.00	SIX WAY WITH OFF (45°)	1	SI063	340.00
TWO WAY NO OFF (90°)	1	SI037	156.00		2	SI083	590.00
	2	SI038	207.00		3	SI103	791.00
	3	SI039	250.00	SEVEN WAY WITH OFF (45°)	1	SI064	346.00
	4	SI040	310.00		2	SI084	590.00
TWO WAY WITH OFF (60°)	1	SI025	160.00		3	SI104	757.00
	2	SI026	207.00	SEVEN WAY WITH NO OFF (45°)	1	SI053	346.00
	3	SI027	250.00		2	SI073	590.00
	4	SI028	310.00		3	SI093	757.00
THREE WAY NO OFF (60°)	1	SI049	182.00	EIGHT WAY WITH NO OFF (45°)	1	SI054	342.00
	2	SI069	250.00		2	SI074	643.00
	3	SI089	364.00		3	SI094	860.00
	4	SI120	424.00	EIGHT WAY WITH OFF (30°)	1	SI065	346.00
THREE WAY WITH OFF (90°)	1	SI060	185.00		2	SI085	643.00
	2	SI080	250.00		1	SI055	397.00
	3	SI100	364.00	NINE WAY WITH NO OFF (30°)	1	SI055	397.00
	4	SI131	442.00		2	SI075	659.00
FOUR WAY NO OFF (90°)	1	SI050	216.00		1	SI066	3930.00
	2	SI070	312.00		2	SI086	704.00
	3	SI090	405.00		1	SI056	417.00
	4	SI121	524.00	TEN WAY WITH OFF (30°)	1	SI056	417.00
FOUR WAY WITH OFF (60°)	1	SI061	216.00		2	SI076	728.00
	2	SI081	361.00		1		
	3	SI101	498.00		2		
	4	SI132	614.00		3		
FIVE WAY NO OFF (60°)	1	SI051	240.00		4		
	2	SI071	400.00		5		
	3	SI091	405.00		6		
FIVE WAY WITH OFF (60°)	1	SI062	234.00		7		
	2	SI082	400.00		8		
	3	SI102	524.00		9		
					10		



CAM OPERATED ROTARY SWITCHES (SWITCHES- 6 AMPS. TYPE 'SC6')

SWITCHING	POLE	PROGRAMME	UNIT PRICE	SWITCHING	POLE	PROGRAMME	UNIT PRICE
TEN WAY WITH NO OFF (30°) 	1	SI067	659.00	ELEVEN WAY WITH OFF (30°) 	1	SI068	669.00
	2	SI087	781.00		2	SI088	846.00
ELEVEN WAY NO OFF (30°) 	1	SI057	659.00	TWELVE WAY NO OFF (30°) 	1	SI058	669.00
	2	SI077	941.00		2	SI078	897.00

AMMETER SELECTOR SWITCHES

SWITCHING	POLE	AMPS.	TYPE	PROGRAMME	DESCRIPTION	UNIT PRICE
	03	06	SC6	SI325	To Read Current To Be Used With Ct With Off	234.00
	03	10	SC10	SI325	--Do--	299.00
	03	10	SC10	SI710		966.00
	03	16	SC16	SI710	Direct Reading	1024.00
	03	25	SC25	SI710	Ammeter Selector	1098.00
	03	32	SC32	SI710	Switches Without Ct's	1190.00
	03	40	SC40	SI710		1726.00
	03	63	SC63	SI710		1904.00

VOLTMETER SELECTOR SWITCHES









SWITCHING	POLE	AMPS.	TYPE	PROGRAMME	DESCRIPTION	UNIT PRICE
	03	06	SC6	SI312	Voltage Between Phase To Phase With Off	180.00
	03	10	SC10	SI312	--Do--	265.00
	03	06	SC6	SI313	Voltage Between Phase To Phase And Phase To Neutral With Off	316.00
	03	10	SC10	SI313	--Do--	549.00
	03	06	SC6	SI311	Voltage Between Phase To Neutral With Off	323.00
	03	10	SC10	SI314	Voltage Between Phase To Phase And Phase To Neutral Without Off	549.00

PHASE SELECTOR SWITCH (PSS SERIES)

M.R.P. (₹) Per Unit

SWITCHING	POLE	PROGRAMME	DESCRIPTION	25 AMPS	32 AMPS	40 AMPS	63 AMPS
	01	SI060	1P 3W with OFF	298.00	342.00	540.00	620.00

CAM OPERATED ROTARY SWITCHES

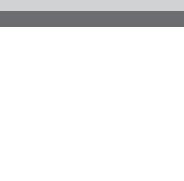
	SWITCHING	POLE	PROGRAMME	10 A. SC10	16 A. SC16	25 A. SC25	32 A. SC32	40 A. SC40	63 A. SC63	100 A. SC100	200 A. SC100
	ON - OFF	1	SI195	232.00	264.00	292.00	336.00	490.00	564.00	1839.00	2115.00
	OFF	2	SI198	278.00	310.00	346.00	390.00	570.00	656.00	2298.00	6242.00
	ON ● ON	3	SI197	309.00	361.00	446.00	500.00	702.00	807.00	2835.00	3260.00
	OFF	4	SI196	329.00	382.00	524.00	600.00	796.00	915.00	3286.00	3779.00
	ON - OFF	1	SI191	232.00	264.00	292.00	336.00	490.00	564.00	1839.00	2115.00
	OFF	2	SI192	278.00	310.00	346.00	390.00	570.00	656.00	2298.00	2642.00
	● ON	3	SI199	309.00	361.00	446.00	500.00	702.00	807.00	2835.00	3260.00
	OFF	4	SI194	329.00	382.00	524.00	600.00	796.00	915.00	3286.00	3779.00
	TWO WAY WITH NO - OFF	1	SI037	299.00	338.00	350.00	419.00	577.00	664.00	2385.00	2743.00
	1	2	SI038	340.00	388.00	480.00	550.00	806.00	927.00	3488.00	4011.00
	2 ● 2	3	SI039	425.00	405.00	666.00	760.00	1235.00	1420.00	4516.00	5193.00
	1	4	SI040	512.00	585.00	703.00	810.00	1240.00	1426.00	5704.00	6559.00
	TWO WAY WITH OFF	1	SI151	299.00	338.00	350.00	400.00	577.00	664.00	2385.00	2743.00
	OFF	2	SI152	340.00	388.00	480.00	550.00	806.00	927.00	3488.00	4011.00
	2 ● 1	3	SI153	425.00	405.00	666.00	716.00	1035.00	1190.00	4516.00	5193.00
	OFF	4	SI154	512.00	585.00	703.00	810.00	1240.00	1426.00	5704.00	6559.00
	THREE WAY WITH OFF	1	SI060	340.00	370.00	442.00	508.00	730.00	840.00	2424.00	2788.00
	OFF	2	SI080	413.00	470.00	608.00	690.00	1036.00	1191.00	3572.00	4107.00
	3 ● 1	3	SI100	509.00	688.00	832.00	950.00	1440.00	1656.00	4648.00	5345.00
	2	4	SI131	658.00	860.00	1002.00	1150.00	1792.00	2061.00	5873.00	6754.00
	FOUR WAY WITH NO OFF	1	SI050	386.00	486.00	513.00	590.00	829.00	953.00	2423.00	2786.00
	1	2	SI070	496.00	525.00	698.00	790.00	1386.00	1594.00	3740.00	4301.00
	4 ● 2	3	SI090	522.00	792.00	1004.00	1154.00	1800.00	2070.00	4927.00	5666.00
	3	4	SI121	767.00	938.00	1202.00	1380.00	2306.00	2652.00	6053.00	6961.00
	FIVE WAY WITH OFF	1	SI062	449.00	523.00	702.00	806.00	1030.00	1185.00	00.00
	OFF	2	SI082	602.00	760.00	974.00	1120.00	1400.00	1610.00	00.00
	5 ● 1 4 ● 2 3	3	SI102	751.00	1100.00	1252.00	1440.00	2026.00	2330.00	11445.00	13162.00
	SIX WAY WITH NO OFF	1	SI052	461.00	536.00	720.00	830.00	1322.00	1521.00	3558.00	4092.00
	1	2	SI072	599.00	815.00	1244.00	1440.00	1890.00	2174.00	7095.00	8159.00
	6 ● 2 5 ● 3 4	3	SI092	806.00	1256.00	1368.00	1570.00	2688.00	3092.00	12062.00	13872.00
	SEVEN WAY WITH OFF	1	SI064	501.00	590.00	740.00	850.00	1377.00	1584.00
	OFF	2	SI084	691.00	874.00	1320.00	1520.00	2153.00	2476.00
	7 ● 1 6 ● 2 5 ● 3 4	3	SI104	1014.00	1322.00	1570.00	1800.00	3215.00	3698.00
	EIGHT WAY WITH NO OFF	1	SI054	561.00	635.00	752.00	864.00	1506.00	1732.00
	1	2	SI074	743.00	712.00	1300.00	1490.00	2540.00	2921.00
	8 ● 2 7 ● 3 6 ● 4 5	3	SI094	1196.00	1368.00	1720.00	1980.00	3598.00	4138.00

ROTARY SWITCHES FOR MOTOR DUTY APPLICATIONS
SCI MAKE CAM OPERATED ROTARY SWITCHES SUITABLE FOR SWITCHING CONTROLLING AND STARTING 3 PHASE 440 VOLTS 50Hz SQUIRREL CAGE INDUCTION MOTORS FOR AC3 AND AC4 DUTIES.

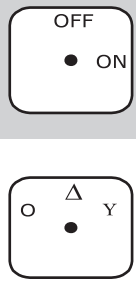
SWITCHING	POLE	AMPS.	TYPE	PROGRAMME	DESCRIPTION	UNIT PRICE	
	03	16	SC16	SI003	ON-OFF SWITCH	370.00	
	03	25	SC25	SI003	ON-OFF SWITCH	466.00	
	03	32	SC32	SI003	ON-OFF SWITCH	547.00	
	03	40	SC40	SI003	ON-OFF SWITCH	757.00	
	03	63	SC63	SI003	ON-OFF SWITCH	905.00	
		03	16	SC16	SI200	STAR-DELTA SWITCH	576.00
		03	25	SC25	SI200	STAR-DELTA SWITCH	757.00
		03	32	SC32	SI200	STAR-DELTA SWITCH	840.00
		03	40	SC40	SI200	STAR-DELTA SWITCH	1513.00
		03	63	SC63	SI200	STAR-DELTA SWITCH	1669.00

FORWARD - OFF - REVERSE SWITCHES

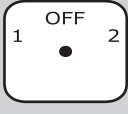
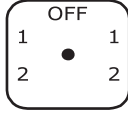
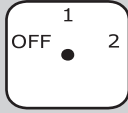
SWITCHING	POLE	AMPS.	TYPE	PROGRAMME	DESCRIPTION	UNIT PRICE
	03	06	SC 6	SI211	THREE POLE REVERSING	234.00
	03	10	SC10	SI211		270.00
	03	16	SC16	SI211		432.00
	03	25	SC25	SI211		524.00
	03	32	SC32	SI211		600.00
	03	40	SC40	SI211		1270.00
	03	63	SC63	SI211		1460.00
	03	25	SC25	SI217	TWO SPEED FORWARD REVERSE SWITCHES	1128.00
	03	25	SC25	SI446	TWO SPEED FORWARD SWITCH IN DIFFERENT PHASE COMBINATION	972.00
	03	25	SC25	SI212	TWO SPEED FORWARD SWITCHES	900.00



w.e.f. Jan. 2022

CHANGEOVER SWITCHES (90° DOUBLE THROW)

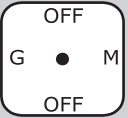
SWITCHING	POLE	PROGRAMME	25 AMPS SC25 (Rs.)	32 AMPS SC32 (Rs.)	40 AMPS SC40 (Rs.)	63 AMPS SC63 (Rs.)
	02	SI152CO	608.00	659.00	936.00	1339.00
	03	SI153CO	792.00	846.00	1172.00	1791.00
	04	SI154CO	1035.00	1087.00	1508.00	2228.00

Additional Price For Sheet Metal Box For 2 Pole Rs. 160.00 For 3 & 4 Pole Rs. 300.00

SWITCHES WITH METAL BOX 60°

	SWITCHING	POLE	PROGRAMME	16 AMPS SC16 (Rs.)	25 AMPS SC25 (Rs.)	32 AMPS SC32 (Rs.)
	Three Pole Reversing (Type SI 211)	03	SI913	846.00	942.00	992.00
	Three Pole On - Off	03	SI244	649.00	774.00	873.00
	Three Pole Reversing	03 03	SI912 SI910	633.00 -----	751.00 -----	791.00 1098.00

SPRING RETURN SWITCHES

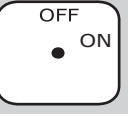
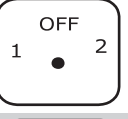
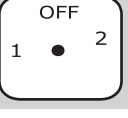
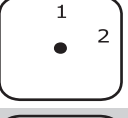
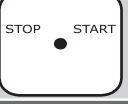
SWITCHING	POLE	PROGRAMME	DESCRIPTION	16 AMPS SC16 (Rs.)	25 AMPS SC25 (Rs.)	
	1	SI351	On-off	384.00	450.00	
	2	SI352	With Spring	447.00	549.00	
	3	SI353	Return To Off	536.00	702.00	
	4	SI354		572.00	822.00	
	1	SI361	Double Throw	482.00	561.00	
	2	SI362	Spring Return	572.00	757.00	
	3	SI363	Both Side To Off	728.00	1005.00	
	1	SI364	Three Position	482.00	561.00	
	2	SI365	With One Position	572.00	757.00	
	3	SI369	Spring Return To Off	728.00	1005.00	
	1	SI371	Two Position	482.00	561.00	
	2	SI372	Spring Return	572.00	757.00	
	3	SI373	Switches 2 To 1	728.00	1005.00	
	1	SI300	Stop-start Switch	482.00	561.00	
	2	SI388	Spring Return To Centre Position	572.00	757.00	

SPRING RETURN SWITCHES FOR CONTROL CIRCUITS (TNC)

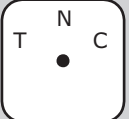
SWITCHING	POLE	PROGRAMME	DESCRIPTION	25 AMPS SC25 (Rs.)	32 AMPS SC32 (Rs.)
	2	SI009	2NO + 2NC	795.00	914.00

SPARES FOR ROTARY SWITCHES

S.No.	DESCRIPTION	SIZE in mm.	UNIT PRICE
I.	INDICATING PLATES (FRONT PLATES)		
	■ 6 TO 16 AMPS	48 x 48	28.00
	■ 25 & 32 AMPS	64 x 64	36.00
	■ 40 & 63 AMPS	88 x 88	48.00
II.	SCRIPT PLATES (MARKING PLATES)		
	■ UP TO 16 AMPS	48 x 48	6.00
	■ 16 TO 32 AMPS	64 x 64	9.00
	■ 40 & 63 AMPS	88 x 88	13.00
III.	KNOBS		
	■ Tear Drop For 6 To 16 Amps	48 x 48, 48 x 60	14.00
	■ Tear Drop For 16 To 32 Amps	64 x 64, 64 x 80	26.00
	■ Tear Drop For 40 & 63 Amps	88 x 88	38.00
IV.	HANDLES		
	■ Flag Handle For 16 Amps	48 x 48, 48 x 60	14.00
	■ Flag Handle For 25 & 32 Amps	64 x 64, 64 x 80	26.00
	■ Ball Handle For 16 To 32 Amps	64 x 64, 64 x 80	40.00
	■ Ball Handle For 40 & 63 Amps	88 x 88	64.00
	■ Pistol Grip Handle For 16 To 32 Amps	64 x 64, 64 x 80	48.00
	■ Long Handle For 16 To 32 Amps	64 x 64, 64 x 80	48.00
	■ Lever Handle For 40 & 63 Amps	88 x 88	70.00
V.	MOUNTING PLATES (FOR REAR MOUNTING)		
	■ 6 TO 16 AMPS	48 x 48	6.00
	■ 25 & 32 AMPS	64 x 64	12.00
	■ 40 & 63 AMPS	88 x 88	18.00

TERMS AND CONDITIONS

1. This supercedes all previous price lists.
2. The prices mentioned in the list are exclusive of GST which shall be charged extra as applicable at the time of dispatch.
3. The prices are on F. O. R. Delhi Basis.
4. Insurance charges shall be extra at actual, if asked for.
5. The prices are subject to change without notice.
6. Our standard terms and conditions applicable to above prices.
7. All disputes are subject to Delhi jurisdiction.
8. All prices are in Indian Rupees.
9. The company reserves the rights to issue amendments, which may arise due to any errors in the price list.



AN ISO 9001 : 2015 COMPANY

For details Product Information Contact :

SWITCH CONTROL (INDIA)

A - 5/5, Jhilmil Industrial Area, Delhi-110 095

Email : scidelhi@ndb.vsnl.net.in, info@switchcontrolindia.in

Website : www.switchcontrolindia.in

